

REV	ECD NO.	DESCRIPTION

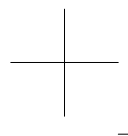
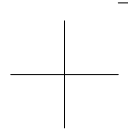
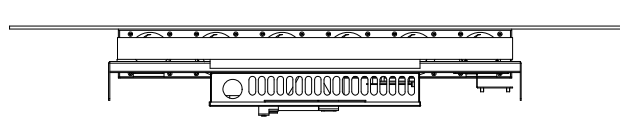
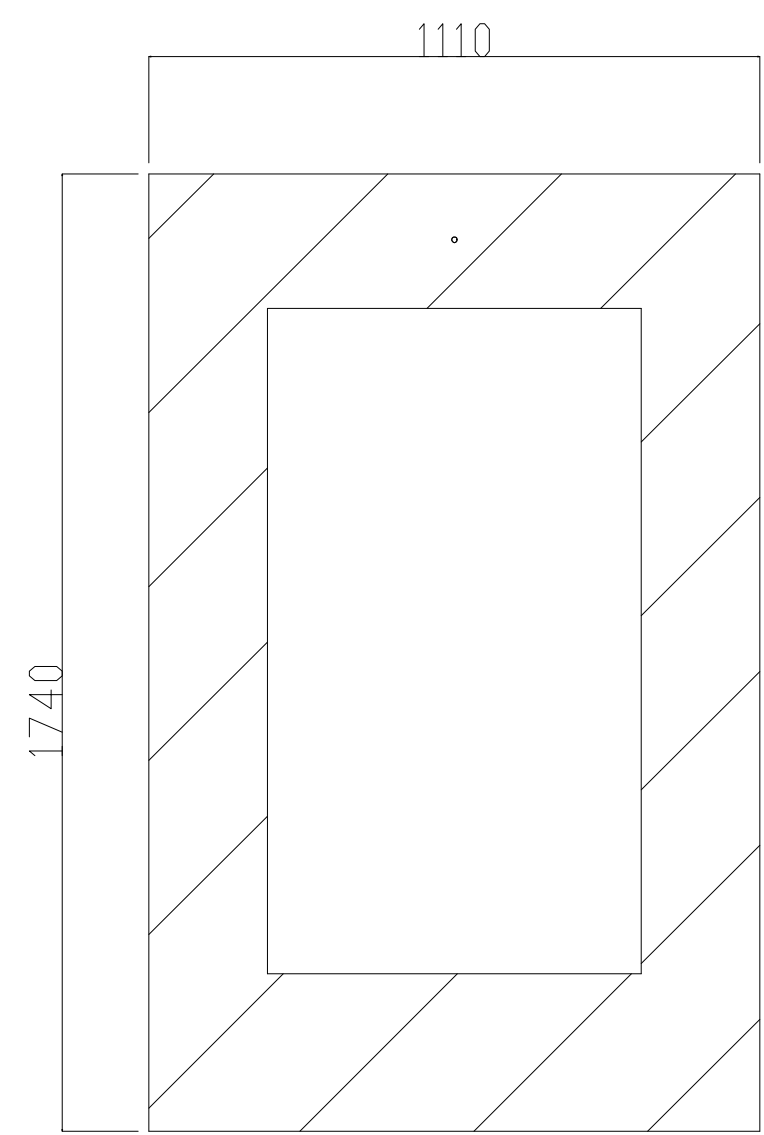
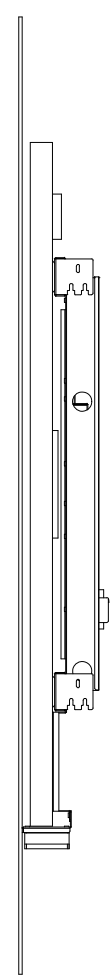
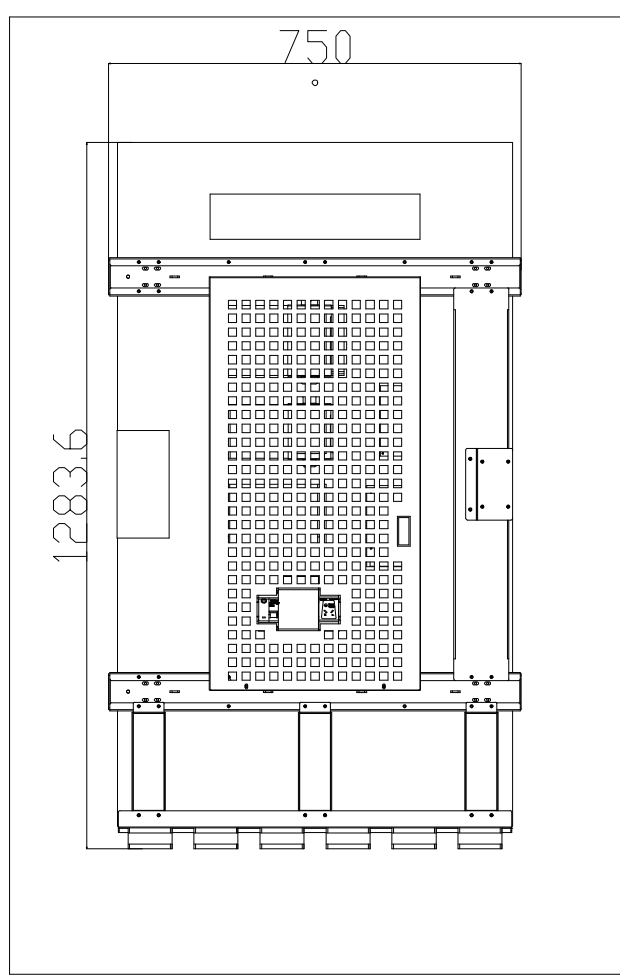
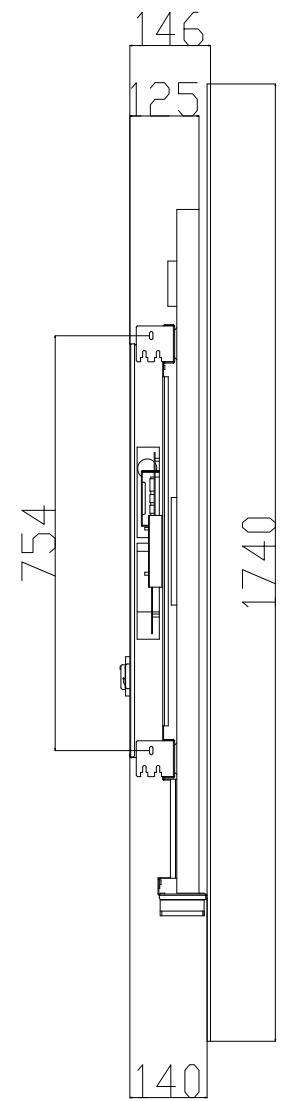
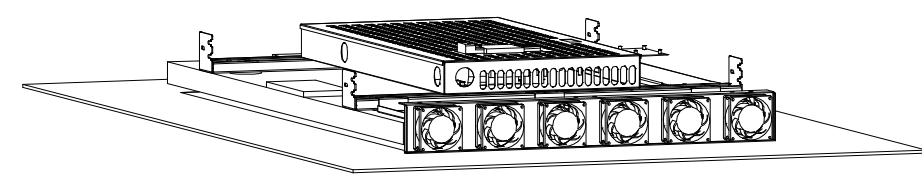
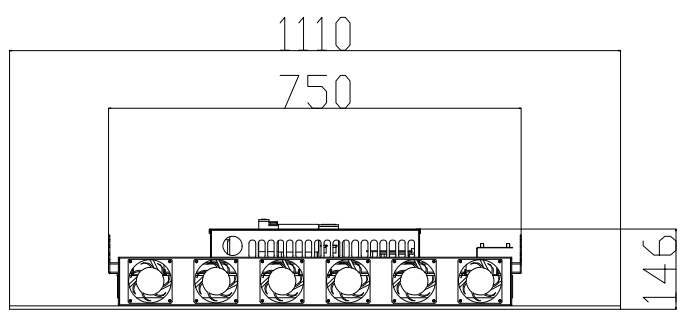

RELEASE LEVEL:  
FILE NAME:

X	±0,1			TITLE:	
XX	±0,01				
.XXX	±0,001	ANG	±0,5	DATE: 25-Jun-23	UNIT'S: MM
				CHKD:	DWG NO:
				STAD:	DATE:
				APPD:	DATE:
				PRODUCT:	DATE:
				FINISH:	MASS(Kg):
				SCALE:	PART NO:
				SHEET: 1 OF 1	REV
				MAT'L:	

A3